

THIS DETAIL IS NOT FOR CONSTRUCTION

SECTION: 9

NOTE: DUE TO KIRBY BUILDING SYSTEMS CONTINUING PROGRAM OF PRODUCT IMPROVEMENT, OUR CURRENT CUSTOM ERECTION DRAWINGS ARE BEING UPDATED. IF THERE IS A DISCREPANCY BETWEEN THIS DETAIL AND YOUR ERECTION DRAWINGS, THE ERECTION DRAWINGS GOVERN. ANY REFERENCES TO THIS DETAIL ARE SUBJECT TO CHANGE WITHOUT NOTICE.

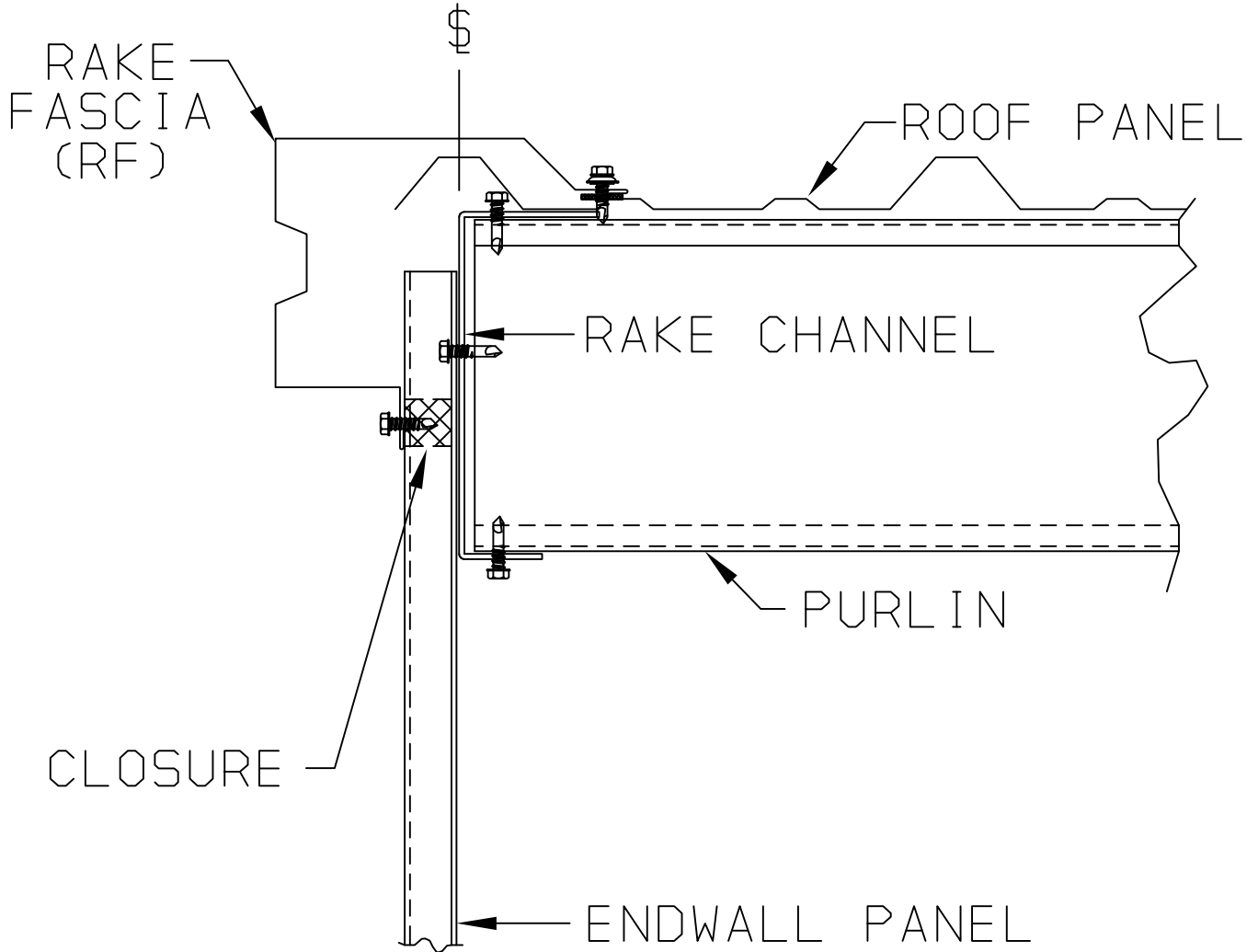

CM-SPL100

RAKE CONDITION FOR ROOF SLOPES 2:12 OR LESS

ISSUE DATE: 3-17-06 REV.:# REV.:# REV.:# REV.:#

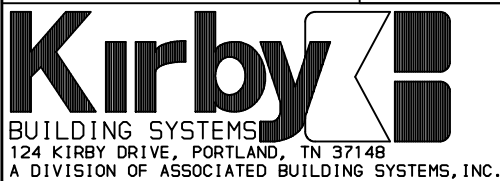

CM-SPL100

COMPUTER SERVICES NUMBER: CED_CM-SPL100

THIS DETAIL IS NOT FOR CONSTRUCTION

SECTION: **9**

NOTE: DUE TO KIRBY BUILDING SYSTEMS CONTINUING PROGRAM OF PRODUCT IMPROVEMENT, OUR CURRENT CUSTOM ERECTION DRAWINGS ARE BEING UPDATED. IF THERE IS A DISCREPANCY BETWEEN THIS DETAIL AND YOUR ERECTION DRAWINGS, THE ERECTION DRAWINGS GOVERN. ANY REFERENCES TO THIS DETAIL ARE SUBJECT TO CHANGE WITHOUT NOTICE.

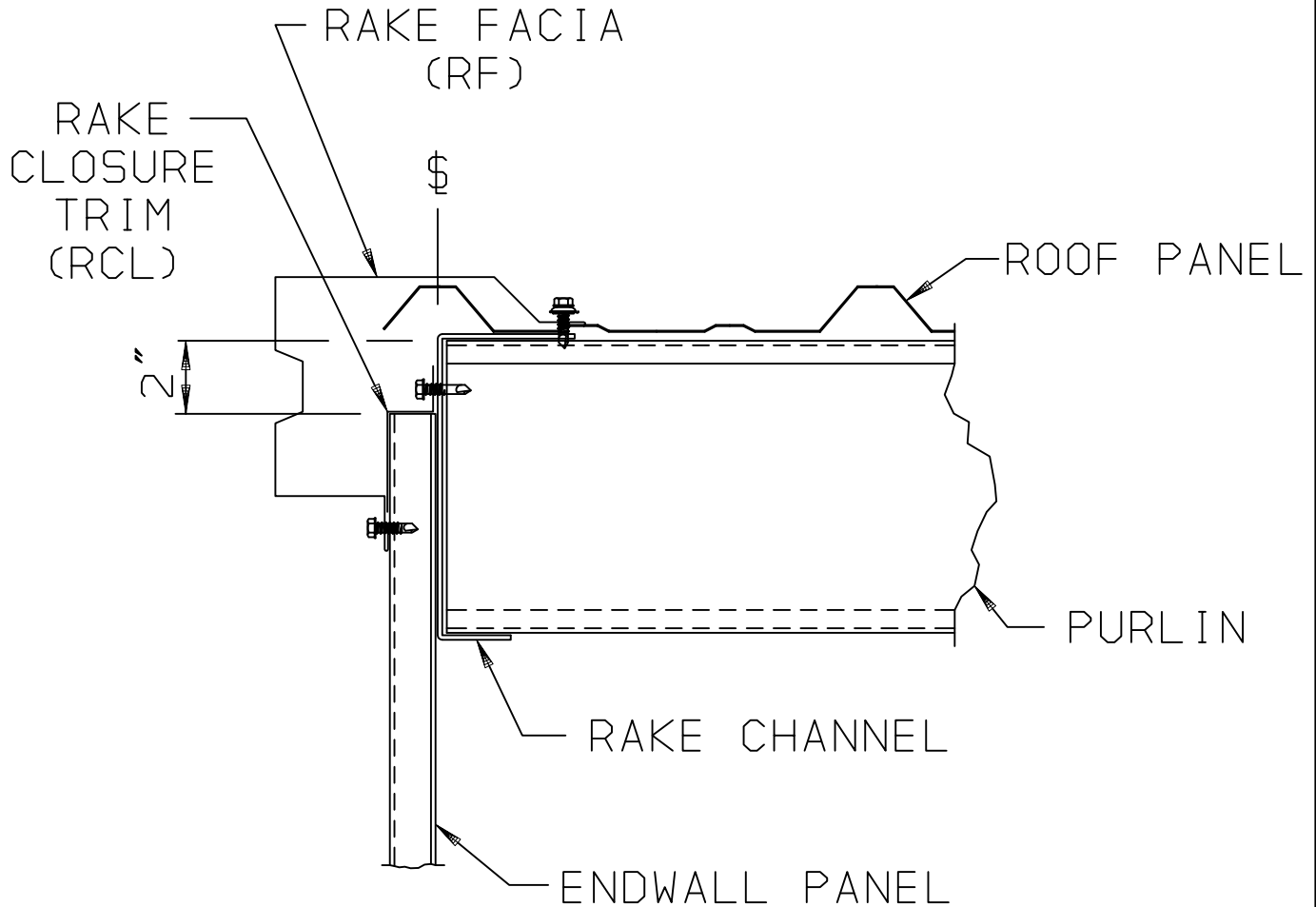

CM-SPL188

**RAKE CONDITION FOR ROOF SLOPES
GREATER THAN 2:12**

ISSUE DATE: 3-17-06

REV.:

REV.:

REV.:

REV.:



BUILDING SYSTEMS
124 KIRBY DRIVE, PORTLAND, TN 37148
A DIVISION OF ASSOCIATED BUILDING SYSTEMS, INC.

CM-SPL188

COMPUTER SERVICES NUMBER: **CED_CM-SPL188**

THIS DETAIL IS NOT FOR CONSTRUCTION

SECTION: 9

NOTE: DUE TO KIRBY BUILDING SYSTEMS CONTINUING PROGRAM OF PRODUCT IMPROVEMENT, OUR CURRENT CUSTOM ERECTION DRAWINGS ARE BEING UPDATED. IF THERE IS A DISCREPANCY BETWEEN THIS DETAIL AND YOUR ERECTION DRAWINGS, THE ERECTION DRAWINGS GOVERN. ANY REFERENCES TO THIS DETAIL ARE SUBJECT TO CHANGE WITHOUT NOTICE.

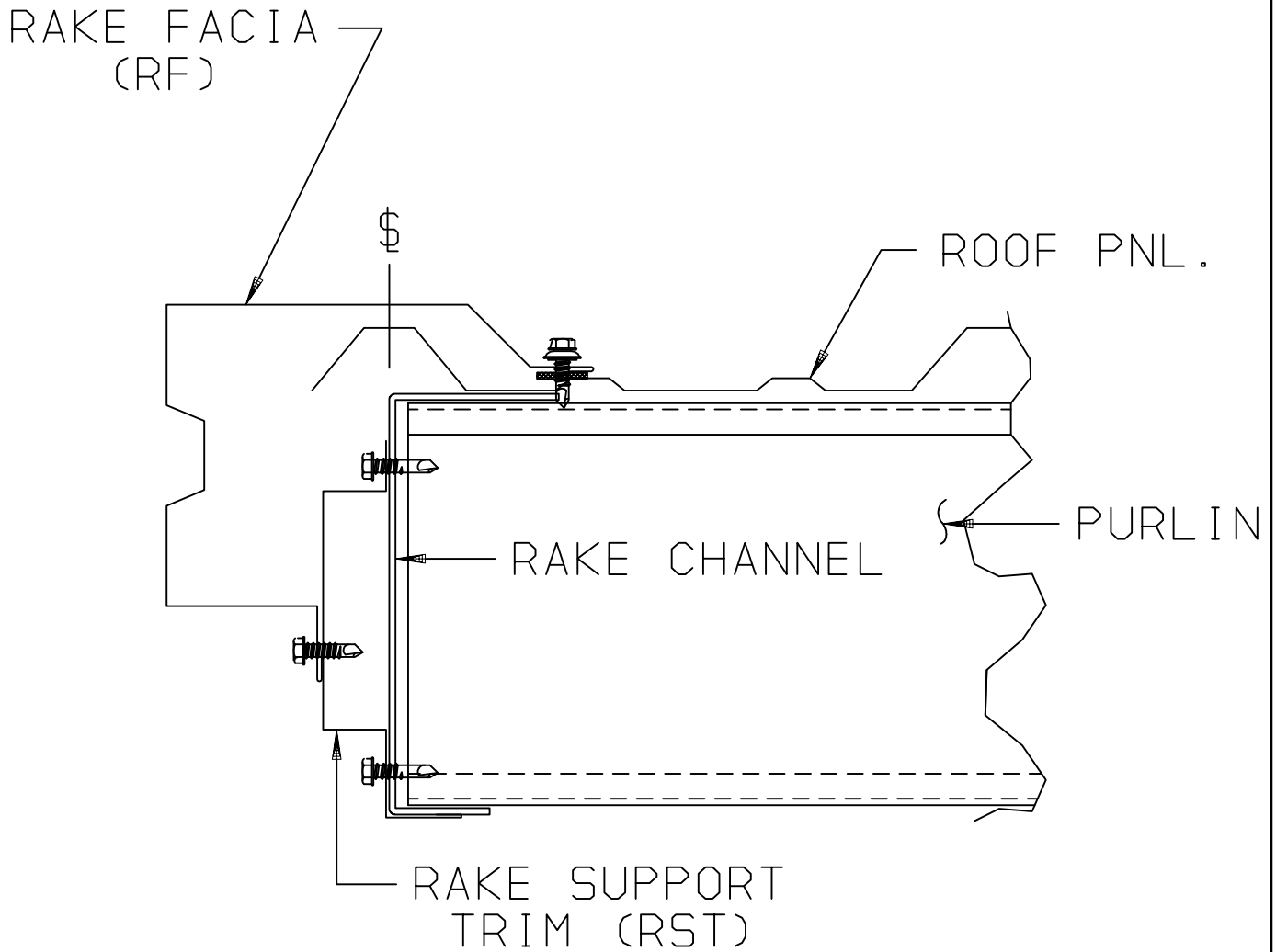

CM-SPL101

RAKE CONDITION WITH OPEN ENDWALL

ISSUE DATE: 3-17-06

REV.:

REV.:

REV.:

REV.:



BUILDING SYSTEMS
124 KIRBY DRIVE, PORTLAND, TN 37148
A DIVISION OF ASSOCIATED BUILDING SYSTEMS, INC.

CM-SPL101

COMPUTER SERVICES NUMBER: CED_CM-SPL101

THIS DETAIL IS NOT FOR CONSTRUCTION

SECTION: 9

NOTE: DUE TO KIRBY BUILDING SYSTEMS CONTINUING PROGRAM OF PRODUCT IMPROVEMENT, OUR CURRENT CUSTOM ERECTION DRAWINGS ARE BEING UPDATED. IF THERE IS A DISCREPANCY BETWEEN THIS DETAIL AND YOUR ERECTION DRAWINGS, THE ERECTION DRAWINGS GOVERN. ANY REFERENCES TO THIS DETAIL ARE SUBJECT TO CHANGE WITHOUT NOTICE.

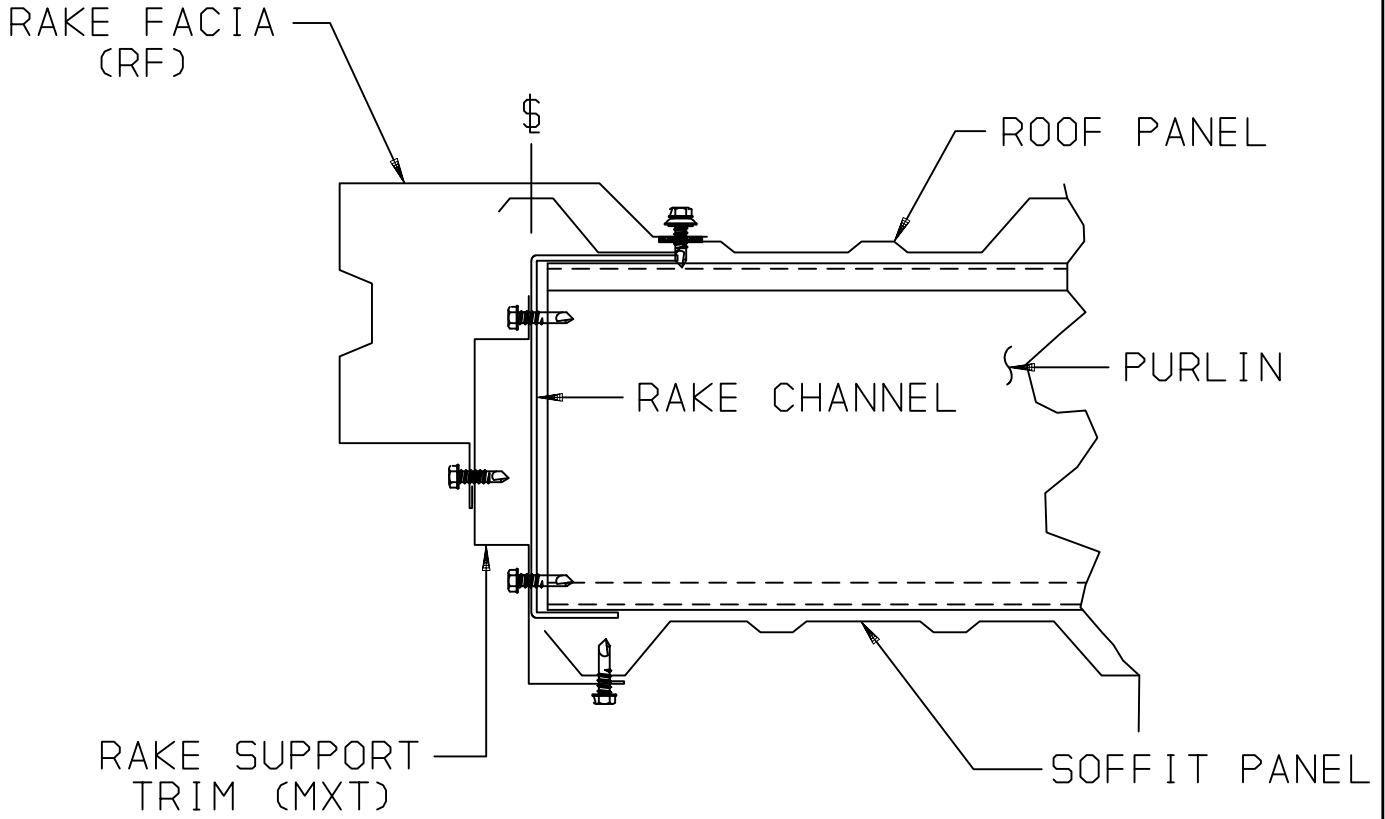

CM-SPL126

RAKE EXTENSION WITH SOFFIT

ISSUE DATE: 3-17-06 REV.:# REV.:# REV.:# REV.:#



BUILDING SYSTEMS
124 KIRBY DRIVE, PORTLAND, TN 37148
A DIVISION OF ASSOCIATED BUILDING SYSTEMS, INC.

CM-SPL126

COMPUTER SERVICES NUMBER: CED_CM-SPL126

THIS DETAIL IS NOT FOR CONSTRUCTION

SECTION: **9**

NOTE: DUE TO KIRBY BUILDING SYSTEMS CONTINUING PROGRAM OF PRODUCT IMPROVEMENT, OUR CURRENT CUSTOM ERECTION DRAWINGS ARE BEING UPDATED. IF THERE IS A DISCREPANCY BETWEEN THIS DETAIL AND YOUR ERECTION DRAWINGS, THE ERECTION DRAWINGS GOVERN. ANY REFERENCES TO THIS DETAIL ARE SUBJECT TO CHANGE WITHOUT NOTICE.

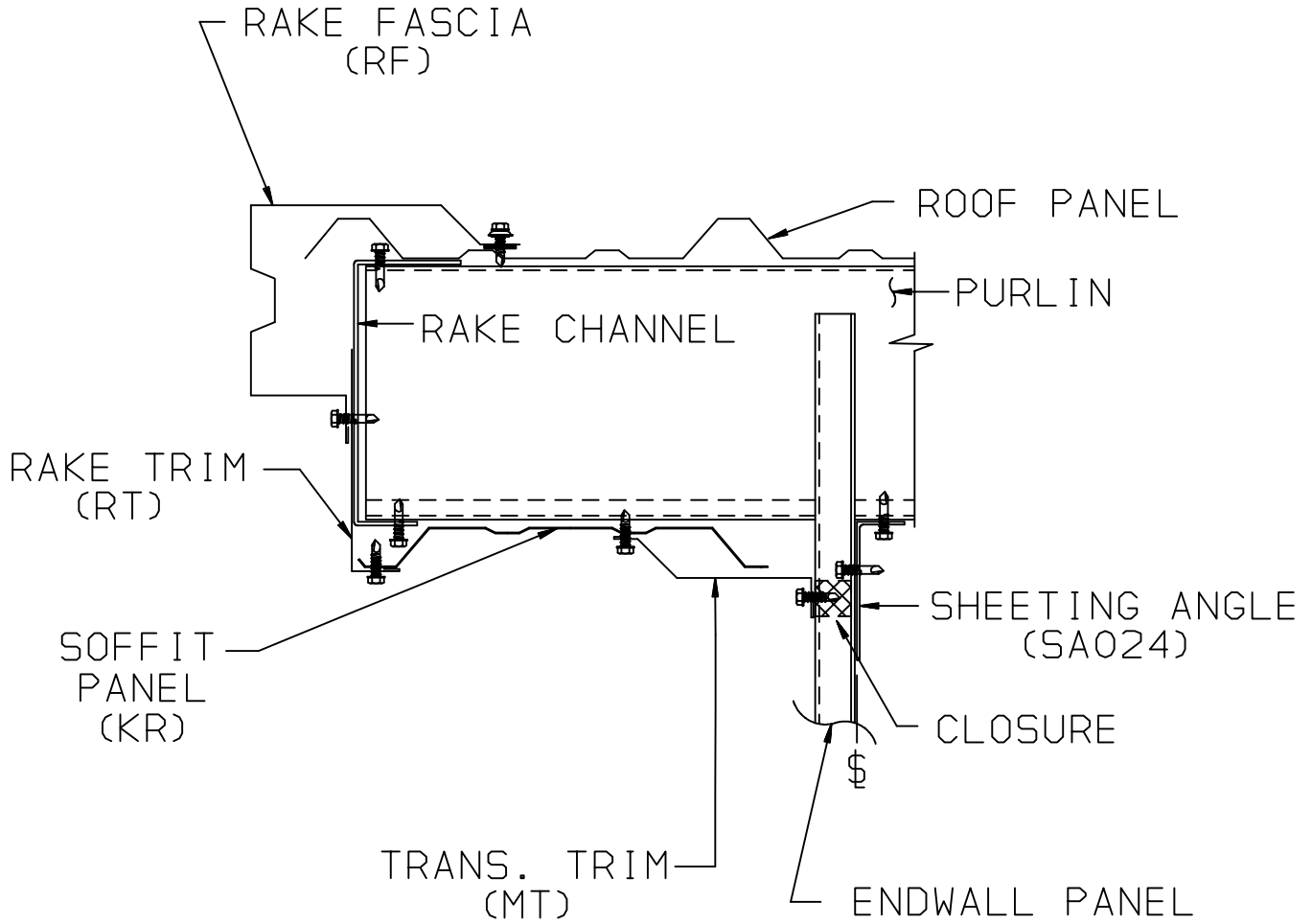

CM-SPL103

**RAKE EXTENSION W/ SOFFIT PANEL
FOR ROOF SLOPES 2:12 OR LESS**

ISSUE DATE: 3-17-06

REV.:

REV.:

REV.:

REV.:



BUILDING SYSTEMS
124 KIRBY DRIVE, PORTLAND, TN 37148
A DIVISION OF ASSOCIATED BUILDING SYSTEMS, INC.

CM-SPL103

COMPUTER SERVICES NUMBER: **CED_CM-SPL103**

THIS DETAIL IS NOT FOR CONSTRUCTION

SECTION: 9

NOTE: DUE TO KIRBY BUILDING SYSTEMS CONTINUING PROGRAM OF PRODUCT IMPROVEMENT, OUR CURRENT CUSTOM ERECTION DRAWINGS ARE BEING UPDATED. IF THERE IS A DISCREPANCY BETWEEN THIS DETAIL AND YOUR ERECTION DRAWINGS, THE ERECTION DRAWINGS GOVERN. ANY REFERENCES TO THIS DETAIL ARE SUBJECT TO CHANGE WITHOUT NOTICE.

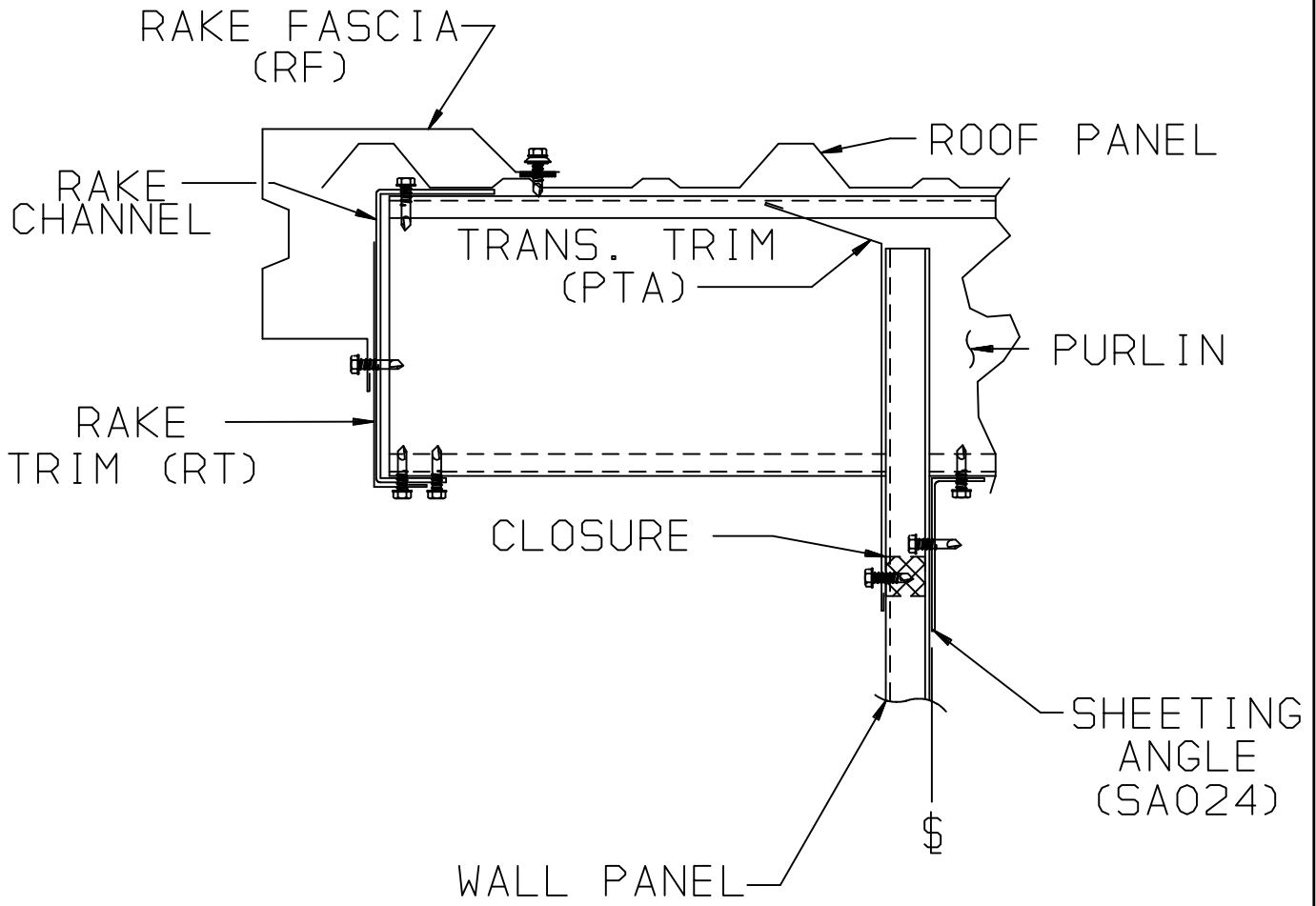

CM-SPL102

RAKE EXTENSION W/O SOFFIT PANEL

ISSUE DATE: 3-17-06 REV.:# REV.:# REV.:# REV.:#

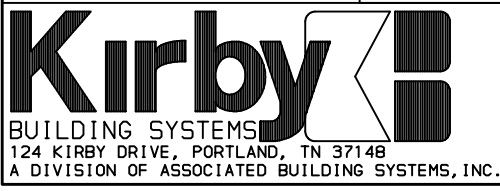

CM-SPL102

COMPUTER SERVICES NUMBER: CED_CM-SPL102